

IND711Z-RWTN

2 Megapixel Premium Series IP IR WDR Dome Camera

Infinique offers a wide range of IP based high definition cameras available in various housing formats, including Box, Dome and Bullet. Our cameras are equipped with superior image sensor and digital signal processor to produce sharp, crisp pictures and are enclosed in weather and vandal resistant housings making it suitable for use in all security applications. The ONVIF compliance of the cameras helps in easy integration, providing peace of mind for your investment. From small to very large installations, Infinique’s cameras are reliable, future proof and an ideal solution for your video surveillance needs.

The IND711Z-RWTN is a 2 Megapixel 130dB WDR IR Dome Camera with Motorized Zoom. It is built with a sturdy plastic housing, incorporating a 1/2.8” high quality image sensor and IR LEDs to provide clear crisp images both during the Day and Night.

The camera comes equipped with a 2.8~8mm motorized zoom lens for easy setup of field of view. The auto iris control allows the camera to automatically set its iris position to maximize image quality in all lighting conditions. The camera streams real-time video at high definition resolution using H.264 or H.265 compression optimizing the bandwidth and increasing storage efficiency.

Built-in PoE for powering the camera and the flexible 3-axis bracket for fixing it on ceiling or wall, provides the convenience for installers to complete the installation quickly and with ease. These versatile cameras are suitable for video surveillance of government buildings, residential apartments, schools, colleges, universities, shopping malls, hospitals, hotels, industrial parks, and corporate offices.

Product Features

- 1/2.8” Progressive Sensor
- 2 Megapixel Resolution
- Up to 30fps at 1920 x 1080
- IR Distance up to 30 meters
- 2.8~8mm Motorized Zoom Lens with DC Auto Iris
- 130dB True WDR
- H.265 and H.264 Compressions
- Up to 3 Simultaneous Video Streams
- S/N Ratio of more than 50dB
- Micro SD Card Slot for Onboard Storage
- Composite Video Output
- Power Over Ethernet (PoE), IEEE 802.3af
- ABS Plastic Housing
- Wall or Ceiling Mount with 3 Axis Bracket
- ONVIF Compliant



Dimensions

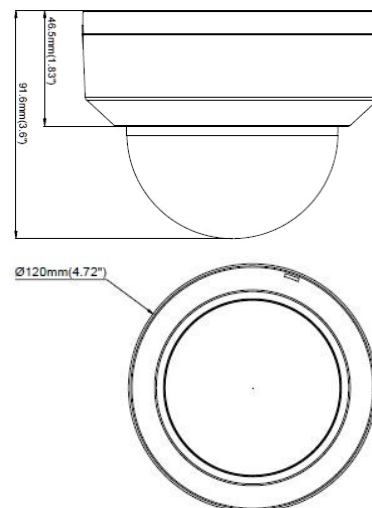

Accessories



Part No: IJBDWM-115
Wall Mount Junction Box



Part No: IJBDCM-115
Ceiling Mount Junction Box



Part No: IBBCFM-1
Ceiling Flush Mount Bracket



Part No: IBDLWM-3
Indoor Wall Mount L Bracket



Part No: IBKTCM
Pendant Ceiling Bracket



Part No: IBBCPM
Pole Mount Bracket



Part No: IBCRWM
Corner Mount Bracket

IND711Z-RWTN

2 Megapixel Premium Series IP IR WDR Dome Camera



IMAGE PERFORMANCE		LOCAL STORAGE	
Image Sensor	1/2.8" Progressive Sensor	Storage Type	Micro SD Card, Max up to 128GB
Effective Pixels (H x V)	1920 × 1080	Recording	Video and Image; Auto / Schedule/ Manual / On Event
Resolution (Megapixels)	2	NETWORK	
Minimum Illumination	0.002 lux (AGC ON) 0 lux with IR ON	Network Port	10/100M BASE-TX, RJ-45 Connector
Image Rate (FPS)	30	Cabling Type	Category 6 and higher
S/N Ratio	More than 50dB	Network Protocol	IPv4, HTTP, HTTPS, TCP/IP, Unicast/Multicast, UDP, RTP, RTSP, RTCP, DNS, DDNS, DHCP, FTP, NTP, PPPOE, SMTP, SNMP, UPNP, IEEE802.1X
IR Distance (m)	30	ONVIF Protocol	ONVIF Compliant
LENS		Security	User Access with password protection, IP Filtering
Focal Length (mm)	2.8~8 Motorized Zoom Lens	Users	1 Administrator, 6 Users
Iris	DC Auto Iris	Simultaneous Viewing	Up to 5 users
Lens Mount	M14	PC Web Browser	IE 6.0 Above; Mozilla Firefox; Google Chrome
Aperture Ratio	F1.2	Mobile Device	iOS, Android
Angle of View (deg)	H:105 (Wide)~46 (Tele), V:56 (Wide)~26 (Tele)	Events	Motion, Tamper Detection, Sensor, Network Failure
VIDEO		Event Handlers	FTP, E-mail, Local Storage
Video Compression	H.265 Main Profile H.264 Baseline Profile/Main Profile/High Profile	MECHANICAL	
Main Stream	1920 x 1080, 1280 x 960, 1280 x 720	Housing ID	V4DIPWH660730S2
Sub Stream	1280 x 720, 640 x 480, 320 x 240	Dimensions (mm)	120 (D) x 91.6 (H)
Mobile Stream	640 x 480, 320 x 240	Weight (g)	390
Electronic Shutter Control	1/5 ~ 1/20,000 sec	Housing	ABS Plastic
Day/Night Control	True Day/Night with IR Cut Filter	Finish	White, RAL 9003
Flicker Control	50 Hz, 60 Hz	Installation	Ceiling Mount / Wall Mount, 3-Axis Bracket
True WDR	130dB, Variable Coefficient	ELECTRICAL	
3D Noise Reduction	Auto / Manual / Disable	Power Consumption	440mA, 5.28W
White Balance	Automatic / Manual	Power Source	PoE IEEE802.3af, DC 12V
Back Light Compensation	On / Off	Power Connector	DC Male Plug
Privacy Mask Zones	Up to 4 Privacy Mask Zones	RTC Backup Battery	3V Magnesium Lithium
Automatic Gain Control	Auto/Manual, Adjustable Level	ENVIRONMENTAL	
Video Output	2 pin terminal block	Operating Temperature (C)	-20 to +60
Video Bit rate	256K-8M, Supports CBR/VBR	Storage Temperature (C)	-20 to +60
OSD	Camera ID, Timestamp	Operating Humidity	0% - 95% non condensing
Image Orientation	Image Flip, Corridor Mode, Rotation	Ingress Protection Rating	IP66
Image Controls	Brightness, Contrast, Hue, Saturation, Sharpness	Impact Rating	IK07
Advanced Functions	Image Rotation, Gain Control, Anti-Fog, Anti-False Color, Anti-Shake, IR Detection	STANDARDS COMPLIANCE	
Motion Detection	Up to 4 Zones	Emissions	FCC Part 15 Subpart B Class B EN 55022:2010 IC ICES-003 Class B
VIDEO ANALYTICS		Immunity	EN 55024:2010
Motion Detection	Multiple Zones	Safety	UL 609501, EU: 2001/95/EC GPSD
Advance Video Analytics	Tamper, Out Of Focus, Sound, Perimeter Intrusion, Line Crossing, Stationary Object, Pedestrian Detection, People Counting, Face Detection		









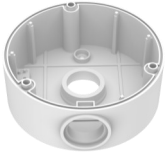

ORDERING INFORMATION	
PART NUMBER	DESCRIPTION
IND711Z-RWTN	Infinique Premium Series Indoor WDR IR Dome Camera, 2MP, 2.8-8mm Motorized Zoom Lens, IR Array LED, 30m IR Range, H.265, H.264, MJPEG, Three Video Streams, 130dB WDR, True Day and Night with ICR, Adjustable Bit Rate, SDHC Slot, ONVIF Compliant, PoE, IP66, IK07
IJBDWM-115	Infinique Wall Mount Junction Box, Base Diameter 115 mm
IJBDCM-115	Infinique Ceiling Mount Junction Box, Base Diameter 115 mm
IBDCFM-1	Infinique Flush Mount Bracket
IBDLWM-3	Infinique Indoor Wall Mount L Bracket
IBKTCM	Infinique Pendant Mount Ceiling Bracket, 45 (D) x 294 (H) mm
IBBCPM	Infinique Pole Mount Bracket with Metal Ties, 125 (L) x 46 (W) x 200 (H) mm
IBCRWM	Infinique Corner Mount Bracket, 200 (L) x 130 (W) x 172.8 (D) mm

IND711Z-RWTN

2 Megapixel Premium Series IP IR WDR Dome Camera



Housing Accessories

WALL MOUNT APPLICATION	CEILING MOUNT APPLICATION	WALL MOUNT APPLICATION	PENDANT MOUNT APPLICATION
 <p>Junction Box IJDWM-115</p>	 <p>Junction Box IJBDCM-115</p>	 <p>L Bracket IBDLWM-3</p>	 <p>Ceiling Bracket IBKTCM</p>
FLUSH MOUNT APPLICATION	POLE MOUNT APPLICATION		
 <p>Ceiling Bracket IBDCFM-1</p>	 <p>Pole Bracket IBBCPM</p>	 <p>Junction Box IJDWM-115</p>	 <p>Junction Box IJBBCM-115</p>
CORNER MOUNT APPLICATION			
 <p>Corner Bracket IBCRWM</p>	 <p>L Bracket IBDLWM-3</p>		



Infinique, a Canadian company is a manufacturer of high performing end-to-end solutions in copper, fiber and video surveillance systems. For more information visit our website at www.infinique.com or email us at sales@infinique.com.