

INO804X-RAT

Premium Series 8MP IR PTZ Camera 4X

Infinique offers a wide range of IP based high definition cameras available in housing formats, including Dome, Bullet, Box and PTZ. Our cameras are equipped with superior image sensor and digital signal processor to produce sharp, crisp pictures and are enclosed in weather and vandal resistant housings making it suitable for use in all security applications. The ONVIF compliance of the cameras helps in easy integration, providing peace of mind for your investment. From small to very large installations, Infinique's cameras are reliable, future proof and an ideal solution for your video surveillance needs.

Infinique's 8MP IR PTZ comes with 4X Optical Zoom. It is compact in size with a reliable mechanical design that offers precise positioning and predictable high-speed tracking. This high quality PTZ dome provides excellent image quality in difficult lighting conditions and provides features such as privacy zone blanking, guard tours, multiple presets, alarms which are required for efficient 24/7 surveillance.

This camera is equipped with smart IR and has a night vision of up to 30m and provides a 355° degree rotation at speed of up to 45° per second and can be used both during day and night.

An easy to install design comes standard with a bracket that allows both wall and ceiling mount making it a suitable choice for any indoor application such as retail stores, restaurants, malls, airports, factories, warehouses, airports, government buildings where detailed video surveillance is essential.

Product Features

- 1/2.7" Progressive Scan Image Sensor
- 8MP Resolution at 25/30 fps
- Smart IR, IR Distance 30m
- Digital WDR
- 4x Optical Zoom
- H.265, H.264 Compression
- Up to 3 Simultaneous Video Streams
- Track targets with 360° Rotation
- Preset/Tour/Scan/Pattern Function
- True Day & Night with ICR Cut Filter
- S/N Ratio of more than 50dB
- Micro SD Card Slot for Onboard Storage
- Audio I/O, Alarm I/O
- ABS Plastic Housing
- IP66 Rated
- Easy control by Keyboard (OSD)
- ONVIF Compliant



Dimensions

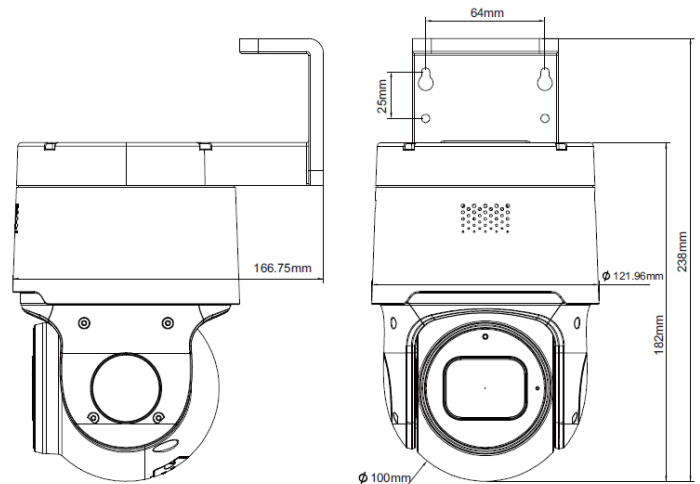

INO804X-RAT

Premium Series 8MP IR PTZ Camera 4X



IMAGE PERFORMANCE	
Image Sensor	1/2.7" Progressive Scan CMOS
Resolution (H x V)	3840 x 2160
Minimum Illumination	Color 0.009 lux with AGC On, B/W 0 lux with IR
Image Rate (FPS)	30
IR Distance (m)	30
IR Dimming	Adjustable
S/N Ratio	More than 50dB
LENS	
Focal Length (mm)	2.8 ~ 12
Iris	DC Auto Iris, Manual
Aperture Ratio	F1.6
Angle of View (deg)	H:113 (Wide)~31.4 (Tele), V:58.4 (Wide)~17.6 (Tele)
Zoom Ratio	4x Optical Zoom
VIDEO AND AUDIO	
Video Compression	H.265 Main Profile H.264 Baseline Profile/Main Profile/High Profile
Main Stream	3840x2160, 2592x1944, 3072x1728, 2592x1520, 2304x1296, 1920x1080, 1280x960, 1280x720
Sub Stream	1280x720, 640x480, 320x240
Mobile Stream	640x480, 320x240
Electronic Shutter Control	1/5 ~ 1/20000
Day/Night Control	IR Cut Filter with Auto Switch
Flicker Control	50 Hz, 60 Hz
WDR	Digital WDR
White Balance	Auto / Manual / Indoor
Backlight Compensation	On / Off
Automatic Gain Control	Auto/Manual, Adjustable Level
Smart Defog	Supported
Audio Compression	G.711A/G.711U/G.726
Audio Input / Output	Built-in Microphone/Speaker
Video Output	IP-RJ45, CVBS-BNC Type
Alarm I/O	1 Inputs, 1 Relay Output (N.O), Built-in Flashing Lights
Video Bit rate	32Kbps~16Mbps, Supports CBR/VBR
OSD	Camera ID, Pan/Tilt Angle, Mode, Zoom Ratio Setting/Control via Joystick
Image Orientation	Image Flip, Mirror
Image Controls	Brightness, Contrast, Hue, Saturation, Acu, Gamma
Advanced Functions	Image Rotation, Anti-Fog, Smart IR Detection
VIDEO ANALYTICS	
Advance Video Analytics	Tamper, Out Of Focus, Sound, Perimeter Intrusion, Line Crossing, Stationary Object, Pedestrian Detection, People Counting, Face Detection, Smart Tracking
LOCAL STORAGE	
Memory Card Slot	Micro SD/SDHC/SDXC, Max 256GB Slot
Recording	Video and Image; Auto / Manual; Motion, Alarm Trigger, Schedule
ORDERING INFORMATION	
PART NUMBER	DESCRIPTION
INO804X-RAT	Infinique Premium Series Outdoor IR PTZ Speed Dome IP Camera, 1/2.7 CMOS Sensor, 8MP, 4X Optical Zoom, H.265, H.264, Three Stream, DWDR, True Day and Night with ICR, Adjustable Bit Rate, ONVIF Compliant, Audio, SDHC Slot, IP66, IK07, Bracket Included
NETWORK	
Network Port	10/100M BASE-TX, RJ-45 Connector
Cabling Type	Category 6 and higher
Network Protocol	IPv4, HTTP, HTTPS, TCP/IP, UDP, RTP, RTSP, RTCP, DNS, DDNS, DHCP, FTP, NTP, PPPOE, SMTP, UPNP, ICMP
ONVIF Protocol	ONVIF Compliant Profile-S/G/T
Security	User Access with password protection, IP Filtering
Users	1 Administrator, 4 Users
PC Web Browser	IE 6.0 Above
Mobile Device	Android, iPhone
Events	Motion, Sensor, Network Failure
Event Handlers	Pre-Post Event Image, FTP, E-mail, SD Card Recording
PTZ CONTROL	
Pan/Tilt Angle (deg)	Pan: 355 / Tilt: 0 to 90
Pan Speed (deg)	0.6° to 45° per sec
Tilt Speed (deg)	0.6° to 38° per sec
Preset Positions	255 Positions
Tour	4 Group Tours, Each tour up to 8 Presets
Scan	1 Programmable Scan
Pattern	4 Patterns
Default Position	Preset / Tour / Scan / Pattern
Communication	RS-485 - 2400, 4800, 9600, 38400 bps
RS-485 Protocol	Pelco-D, Pelco-P
MECHANICAL	
Housing ID	V4POMWH661030S1
Dimensions (mm)	167 (D) x 238 (H)
Weight (g)	920
Housing	ABS Plastic
Finish	White, RAL 9003
Installation	Ceiling / Wall Mount
ELECTRICAL	
Power Consumption	13W
Power Source	PoE IEEE802.3af; DC12V
Power Connector	NA
RTC Backup Battery	3V Magnesium Lithium
ENVIRONMENTAL	
Operating Temperature (C)	-30 to 60
Storage Temperature (C)	-20 to 60
Operating Humidity	0% - 90% non condensing
Ingress Protection Rating	IP66
Impact Rating	IK10
STANDARDS COMPLIANCE	
Emissions	FCC Part 15 Subpart B Class B EN 55022:2010, IC ICES-003 Class B
Immunity	EN 55024:2010
Safety	UL 609501, EU: 2001/95/EC GPSPD



Infinique, a Canadian company is a manufacturer of high performing end-to-end solutions in copper, fiber and video surveillance systems. For more information visit our website at www.infinique.com or email us at sales@infinique.com.